

Rotations Quiz

For the purpose of this quiz, assume we are generally playing a 5-1 offense as described on the last two pages of this document. Answer all questions as if you are facing the net. When drawing each rotation **circle the three front row players**.

1. In rotation 1

- a. Somebody must be closer to the net than the setter who is that? **OH1**
- b. Who does the setter have to stay to the right of? **LIB**
- c. Draw rotation 1 serve-receive assuming we want the opposite to be a primary passer in the passing rotation and the front row outside hitter will pass short balls.

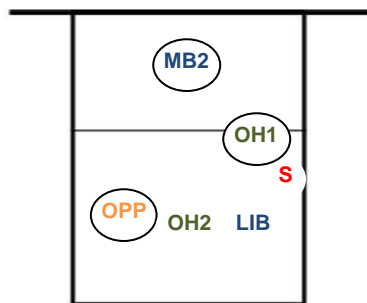

2. In rotation 2

- a. Somebody must be closer to the net than the setter who is that? **OPP**
- b. Who does the setter have to stay between? **LIB and OH1**
- c. The front row outside hitter must be closer to the net than which position? **LIB**
- d. Draw rotation 2 serve-receive.

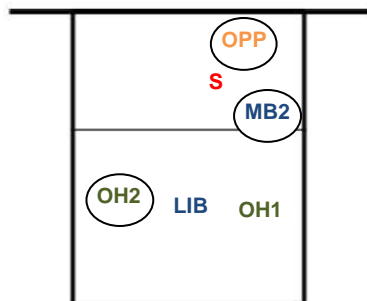

3. In rotation 3

- a. Somebody must be closer to the net than the setter who is that? MB1
- b. The front row outside hitter must be closer to the net than which position? OH1
- c. The setter must be to the left of which position? OH1
- d. Draw rotation 3 serve-receive assuming we want the opposite to pass short balls.

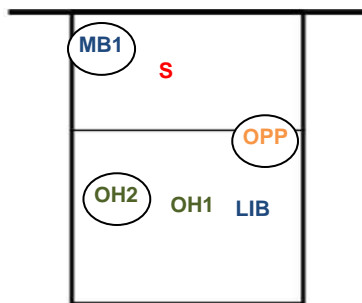

4. In rotation 4

- a. The front row middle blocker must be between which two positions? S and OH2
- b. The front row outside hitter must be closer to the net than which position? OPP
- c. The middle blocker must be closer to the net than which position? LIB
- d. Draw rotation 4 serve-receive assuming we want the opposite to be a primary passer in the passing rotation and the front row outside hitter will pass short balls.

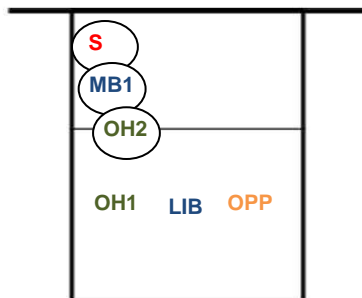

5. In rotation 5

- a. The front row outside hitter must be closer to the net than which position? LIB
- b. Draw rotation 5 serve-receive assuming we want the opposite to be a primary passer in the passing rotation and the front row outside hitter will pass short balls.

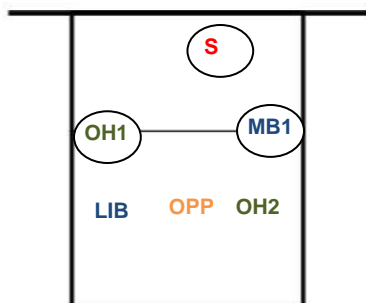

6. In rotation 6

- a. The front row outside hitter must be closer to the net than which position? OH2
- b. Draw rotation 6 serve-receive assuming we want the opposite to be a primary passer in the passing rotation and the front row outside hitter will pass short balls.

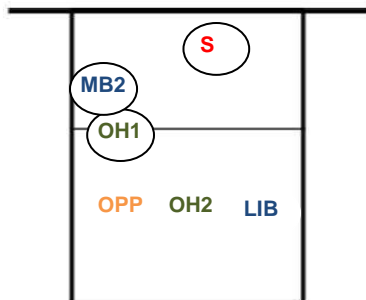

7. When running a 5-1, the setter is front row and able to attack (dump) balls above the net in which rotations? 4, 5, and 6
8. Which position is typically serving in rotation 2 and 5? OH
9. Which positions are typically serving in rotation 3 and 6? MB or LIB
10. Which positions are typically serving in rotation 1 and 4? S or OPP

11. In serve-receive, when can the receiving setter release to move past the person he was standing behind?

- a. When the official blows the whistle?
- b. When the ball is tossed in the air by the server?
- c. When the ball is contacted by the server? c. When the ball is contacted by the server.
- d. When the ball crosses the net?

12. True or False: When I don't know where I am supposed to be, I should just keep quiet and hope the referee doesn't notice.

False, ask a coach or teammate!

13. Assuming the setter is back row.

- a. Draw our base defensive positions.

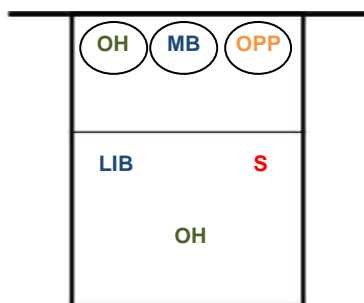

14. Assuming the setter is front row.

- a. Draw our base defensive positions.

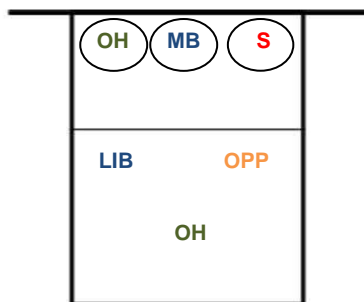

15. If our setter digs the ball he will try to pass it 20 feet high and 10 feet off the net so which position(s) can set the ball?

Libero (or opposite)

16. Who should you ask if you don't know where you are supposed to be on the court?

A coach or teammate

17. On a scale of 1-10 (10 being the most confident), how confident are you in being able to tell ANY position where they are supposed to be in ANY rotation?

Hopefully this is a 10!

Extra Credit:

18. Which rotations are typically used when running a 6-2? 1, 2, and 3

19. True or False: A substitution can occur after the official blows their whistle for a team to serve only if the team calls a timeout. False

20. When doing a player substitution, where do the players stand before entering the court?

At sideline in front of 3m line

21. Where does a libero and the player he replaces enter and exit the court?

At sideline between 3m and end line

22. How many positions may a player substitute in for other players on the court?

One position up to 12 times

23. How many people can the libero serve for?

One position unlimited times

24. Which rotations is the opposite able to easily be moved into the passing rotation to pass deep balls? hint: they are all referred to in previous questions

1, 3, 4, 5, and 6

25. If the opposite was replaced by a setter in rotation 4 and the front row setter was asked to be a hitter, what rotation would it look like?

Rotation 1

26. How many passers do we typically have on the court?

SIX!, EVERYBODY is a passer until told otherwise – however, there are three primary passers in every rotation